













Inhalt:

A		2x
B		1x
C		4x
D		1x
E		1x
F		1x
G		1x
H		1x
I		1x
J		1x
K		1x
L		1x

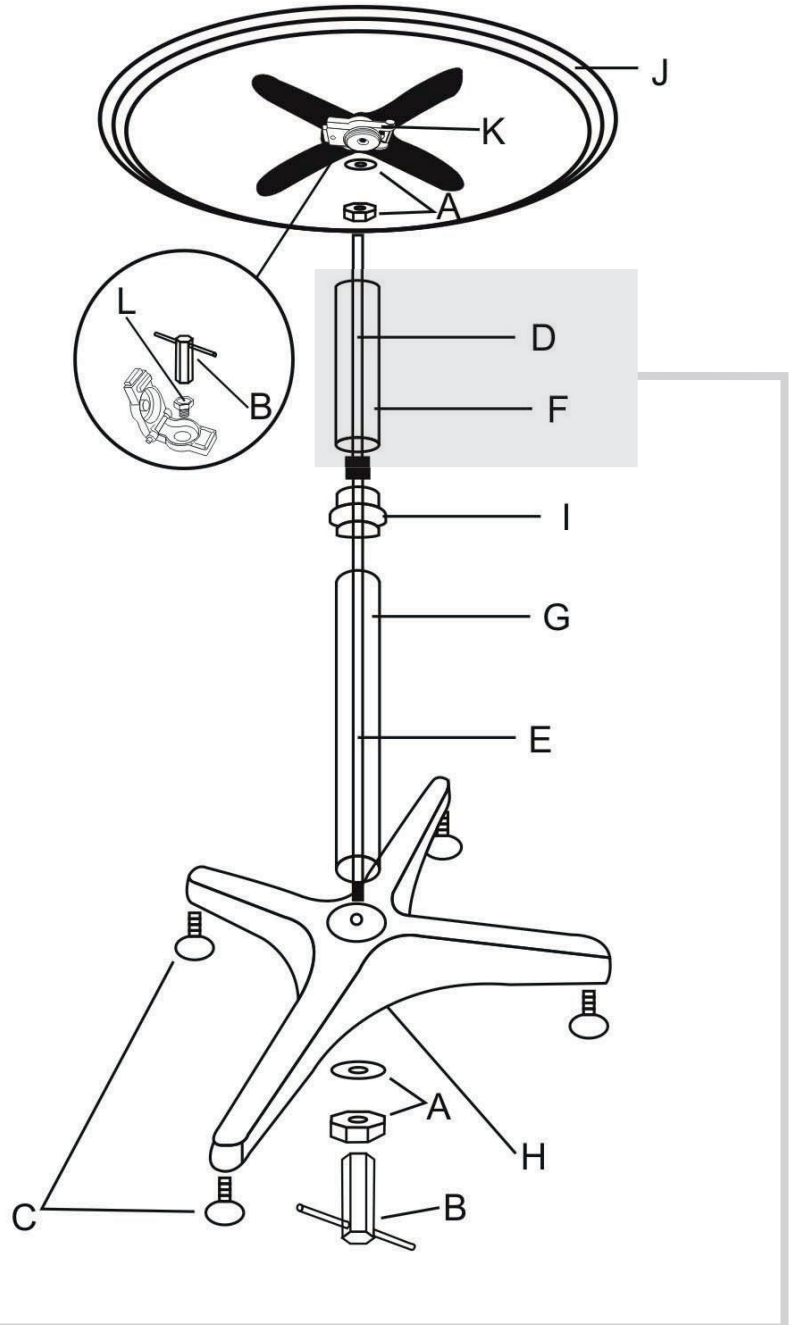

Der Bistrotisch ist in zwei Höhenstufen nutzbar
 Für eine Aufbauhöhe von 70 cm können die Teile
 D und F weggelassen werden.

Für eine Aufbauhöhe von 110 cm müssen alle
 Teile genutzt werden.

Hergestellt für:
 Harms Import & Vertriebs GmbH & Co KG
 Sternkamp 18
 D-26655 Westerstede

76212